

Article number: 2310308005ESD

Description: E+G Antistatic base for levelling elements  
LV.A-70-14-AS-M8x43-ESD-C

## Measures

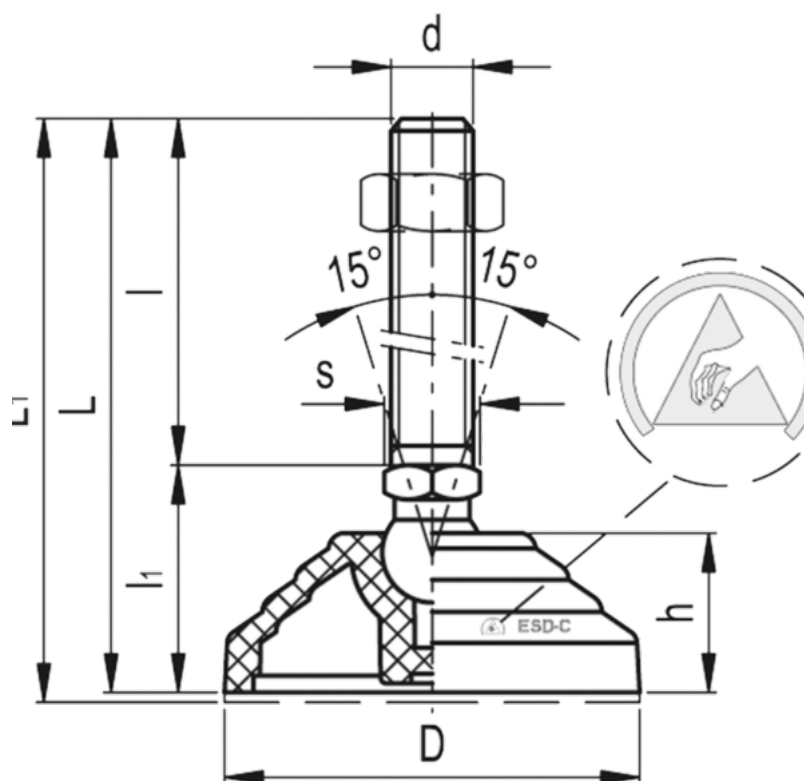

Articulation = 14	Max load = 14000
D = 70	s = 14
d = M8	Weight in (g) = 80
h = 19	
l = 43	
l1 = 28	
L = 71	
L1 = 74	